

# LIMITED ANGLE TORQUE MOTORS



# Limited Angle Torque Motors

H2W Technologies **Limited Angle Torque Motors** are ideal for compact, limited angular excursion (<180°), rotary, closed loop servo applications. Unlike conventional rotary brush and brushless motors, the torquers are wound in such a way that no commutation is required for motion to occur. The result is a much simpler and more reliable system.

Torquers operate on the principal of the **Lorentz Force (Torque) Equation**

$$\text{Force or Torque} = B \times I$$

where: B = Flux density (Tesla)

I = Current (Amps)

Simply stated, a current carrying conductor placed in a magnetic field will have a force (or torque) exerted upon it. This force is proportional to the direction and magnitude of the current and the flux density field. Since the permanent magnet flux density field is fixed, the direction of the rotation depends on the polarity of input current and the amount of torque that is produced is directly proportional to the magnitude of the input current.

A DC linear servo amplifier is required to provide power to the torquer.

The torquers are typically supplied unboxed without bearings or a shaft, but can be supplied boxed if required.

Coupling the torquer to your bearing system and a rotary encoder or other feedback device yields a system that is capable of intricate angular position, velocity, and acceleration control.

Low moving inertia of the rotor assembly allows for high angular acceleration of the payload.

The small length to diameter ratio allows the torquers to fit in spaces where conventional rotary brush and brushless DC motors will not.

It should be noted that, angular excursions of greater than 180° (up to 360°) can be achieved by modifying the winding of the stator assembly. In this case the coil assembly will have 4 leads and it will have to be commutated.

## Advantages:

- No Torque Ripple
- High Angular Acceleration
- No Commutation
- Brushless
- Low Profile

## Applications:

- Aerospace
- Semiconductor
- Medical
- Military

H2W Technologies offers 2 distinct types of limited angle torque motors.

1. **MR Series Limited Angle Torque Motor** - is a toroidally wound iron core stator with a 2, 4 or 6 pole permanent magnet rotor. This torque motor can provide angular excursions up to 180°. It is typically supplied without bearings, shaft or housing to allow for direct mounting to customer supplied bearing system.

**2 Pole MR Torquer**

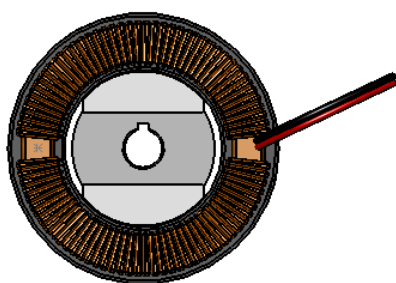

**4 Pole MR Torquer**

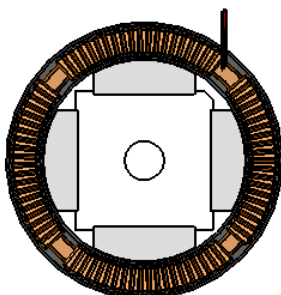

**6 Pole MR Torquer**

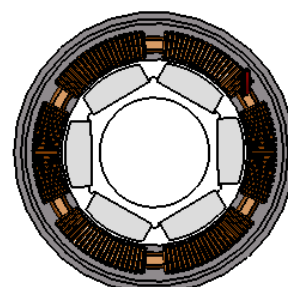

The **MR Series** is comprised of a toroidally wound, stationary, coil assembly with a multi-pole permanent magnet rotor.

**Rotor:** The rare earth permanent magnet rotor always has an even number of poles, with any where from 2 to 6 poles. The maximum angular excursion with a 2-pole rotor is 180°, with a 4 pole rotor is 90°, and with a 6 pole rotor is 60°. The torque will drop off to zero at the extreme ends of the travel. For constant torque over the required rotation, the angular excursion will always be less than numbers mentioned above.

The rotor is comprised of steel core with a thru hole for attaching the rotor to the shaft. Radially magnetized, multipole, rare earth, permanent magnets are bonded to the steel core. Depending on the application either Neodymium or Samarium Cobalt magnets are used.

**Stator:** The stator is comprised of a "soft" magnetic steel toroid that is electrically insulated. Multiple sections of insulated copper magnet wire are toroidally wound on the stator toroid. Only 2 leads are brought out from the stator assembly.

The rotor assembly is installed within the ID of the stator assembly. There is a magnetic attractive force between the stator and the rotor. When the stator is perfectly concentric within the rotor, the radial magnetic attractive forces are equal and opposite and they cancel each other out.

2. **WR Series Limited Angle Torque Motor** – is an arc segmented multipole permanent magnet stator with a low inertia copper magnet wire rotor. Angular excursions are typically less than 90°. This torquer is supplied with out a shaft or bearing.

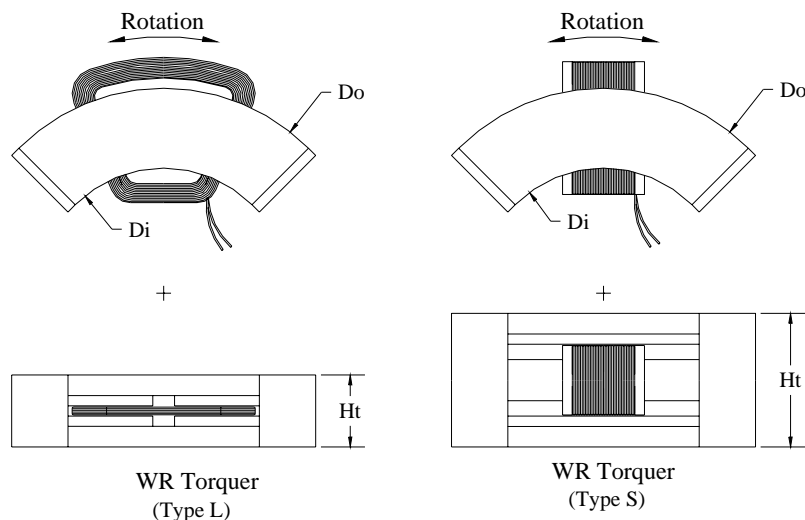

The **WR Series** is comprised of a stationary, arc segmented, multipole permanent magnet stator assembly with a low inertia wound wire rotor.

**Rotor:** The rotor is made up of a single coil of bondable copper magnet wire. The coil is wound and preformed into the desired shape. It is held together with the bonding agents in the wire. It can be encapsulated with aluminum or plastic brackets in order to provide a means for mounting the rotor to the bearing system and payload. The maximum angular excursion is less than 90°.

**Stator:** The stationary stator assembly consists of multipole permanent magnets that are bonded to steel plates. The 2 opposing steel plates are spaced apart to provide a gap using end plates. The coil rotor assembly moves angularly within this gap. There is no magnetic attractive force between the stator and the rotor.

The **WR Series** Torquer is available in 2 configurations.

The low profile (**Type L**) configuration has a smaller overall height which allows it to fit in a more compact space, but has less angular rotation for a given stator arc segment.

The second configuration (**Type S**) has a larger overall height but has typically twice the angular rotation per given stator arc segment when compared to the Type L torquer.

**Required Electronics:**

The motor requires a 1 phase brushless linear amplifier with power supply, that is rated with sufficient current and voltage to meet the motion requirements. A linear amplifier is required because of the very low inductance of the torquer coil assembly. A programmable motion controller is required to close the position loop on the system.

**Environmental Considerations:**

The torquer is a precision device with sensitive components, it should not be mounted in an environment that is wet or excessively dirty. The magnetic assembly is highly magnetic, it should not be placed in an area where loose steel particles can be drawn into the magnetic gap.

The torquer should not be mounted in an environment with high ambient temperatures (>50°C).

**Mounting:**

The torquer is typically supplied with out bearings and a shaft. This allows for the stationary and moving parts of the torquer to be mounted directly to the customers rotary payload assembly. The 2 components of the torquer should be mounted such that they are concentric to one another within .001". The rotor and the stator will have a mounting provisions to allow for attachment to the customers system.

**Maintenance:**

The torquer requires no maintenance.

**Ordering Info:**

Torquers can be ordered for any angular excursion up to 360° and continuous torques up to 1000 ounce-inches. The torquers are built as the orders are placed, they are not stocked, as each customer requirement is different.

Model #

TMR – AAA – BB – CCC - D

or

TWR– AAA – BB – CCC - D

where: AAA is the angular rotation (120° is -120)  
 BB is the OD of the torquer (3.5 inch width is -35)  
 CCC is the continuous torque (250 oz-in is -250)  
 D is for special options

TMR is the MR series torquer and TWR is a WR series torquer.

(i.e. TMR-120-35-250-0 is a 3.5" OD limited angle torque motor with a 120° angular excursion, 250 oz-in of continuous torque and no special options)

| P/N                   | Continuous Torque Angular Displacement | Type | # of Poles | Continuous Torque | Peak Torque | Outside Diameter | Height       | Housed w/ Bearings |
|-----------------------|--|------|------------|-------------------|-------------|------------------|--------------|--------------------|
|                       |  |      |            | oz-in (Ncm)       | oz-in (Ncm) | inches (mm)      | inches (mm)  |                    |
| TMR-010-002-2H        | 10°                                    | MR   | 2          | 2 (1.4)           | 6 (5.2)     | 1 (25.4)         | 1.07 (27.2)  | yes                |
| TWR-010-250-8LST **   | 10°                                    | WR   | 8          | 200 (141)         | 600 (423)   | 5.50 (139.7)     | 4.90 (124.4) | yes                |
| TMR-016-007-6         | 16°                                    | MR   | 6          | 4.0 (2.8)         | 11.0 (7.7)  | 1.60 (40.6)      | 0.40 (10.1)  | no                 |
| TMR-020-010-4         | 20°                                    | MR   | 4          | 10 (7.1)          | 30 (21.3)   | 2.2 (55.9)       | 0.6 (15.2)   | no                 |
| TMR-020-270V          | 20°                                    | MR   | 4          | 265 (187)         | 795 (560)   | 5.25 (133.4)     | 1.70 (43.2)  | no                 |
| TMR-040-010-4         | 40°                                    | MR   | 4          | 10.0 (7.0)        | 30.0 (21.1) | 2.50 (63.5)      | 0.60 (15.2)  | no                 |
| TMR-040-438-4H        | 40°                                    | MR   | 4          | 438 (309)         | 1314 (927)  | 4.25 (108)       | 2.7 (68.6)   | yes                |
| TMR-040-875-4H        | 40°                                    | MR   | 4          | 875 (617)         | 2625 (1851) | 5.54 (141)       | 2.7 (68.6)   | yes                |
| TMR-060-005-2H *      | 90°                                    | MR   | 2          | 5.0 (3.5)         | 15.0 (10.6) | 1.78 (45.2)      | 1.12 (28.4)  | yes                |
| TMR-060-100-2V        | 60°                                    | MR   | 2          | 250 (176)         | 750 (529)   | 4.50 (114.3)     | 1.85 (46.9)  | no                 |
| TMR-075-10-005-2H     | 75°                                    | MR   | 2          | 1.0 (0.7)         | 3.0 (2.1)   | 1.00 (25.4)      | 0.60 (15.2)  | yes                |
| TWR-100-182-400-3P*** | 100°                                   | WR   | 3          | 400 (282)         | 1200 (846)  | 18.20 (462.2)    | 1.45 (36.8)  | no                 |

\* Can be supplied with encoder

\*\* Water proof (IP-67), supplied with tachometer

\*\*\* Arc segmented torquer

MR indicates permanent magnet rotor

WR indicates wound rotor

**Please Note:** The maximum angle of rotation is 360 degrees divided by the number of poles, however the angle indicated above indicates continuous torque range, which is in the middle of the angle of rotation. Outside of that range, the torque generated decreases.

### 2 Pole MR Torquer

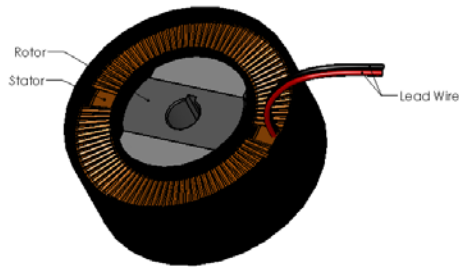

### 4 Pole MR Torquer

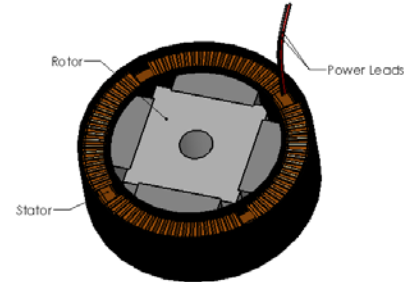

### 6 Pole MR Torquer

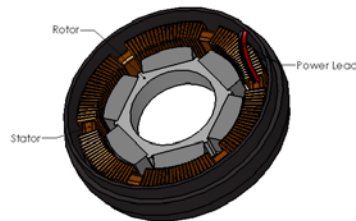

# 2 Pole MR Torquer

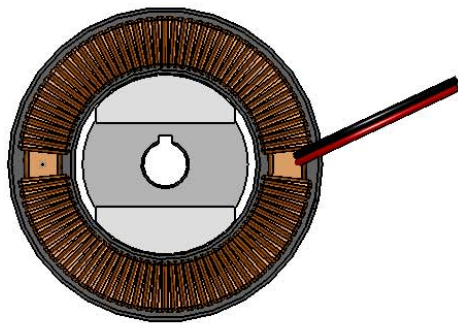
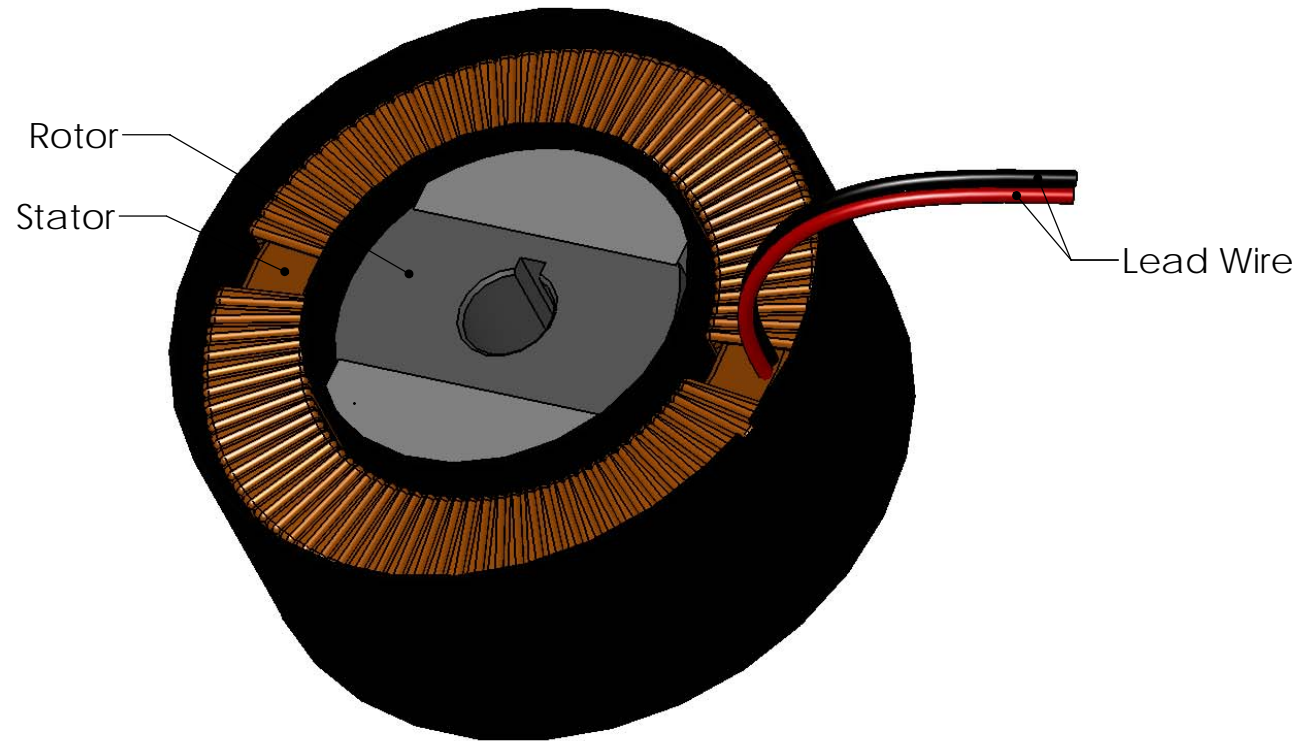

TOP

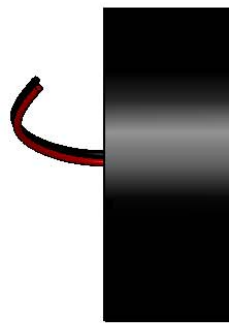

SIDE

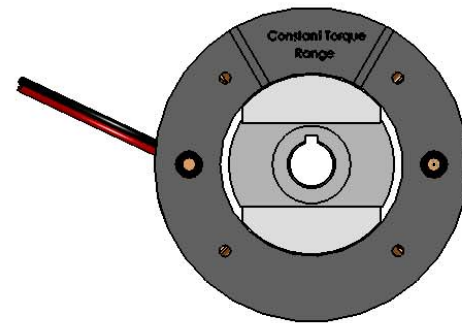

BACK

# 4 Pole MR Torquer

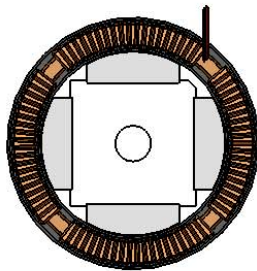
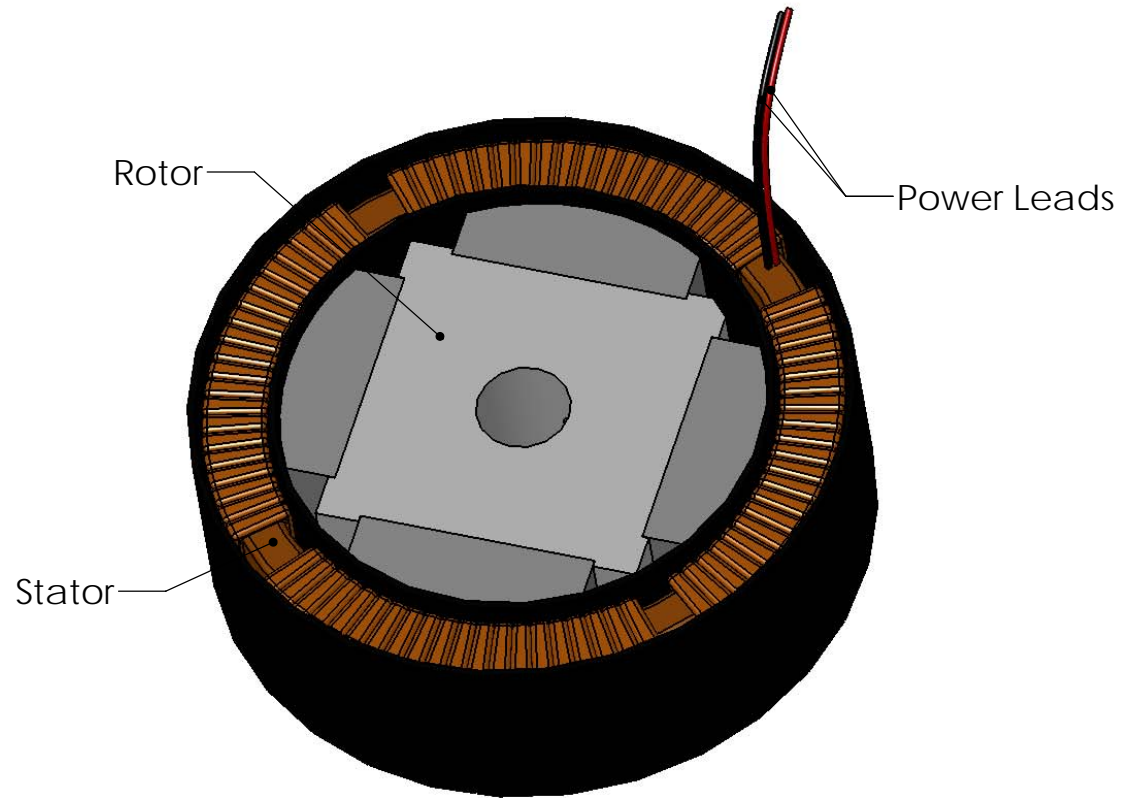

TOP

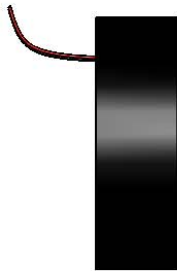

SIDE

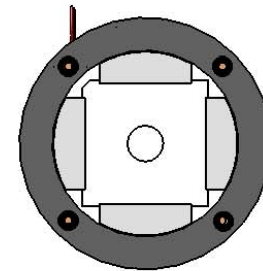

BOTTOM

# 6 Pole MR Torquer

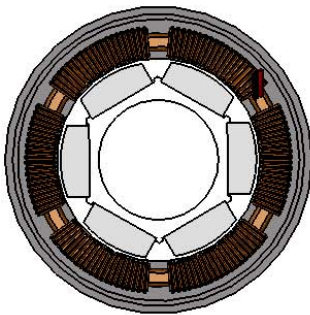
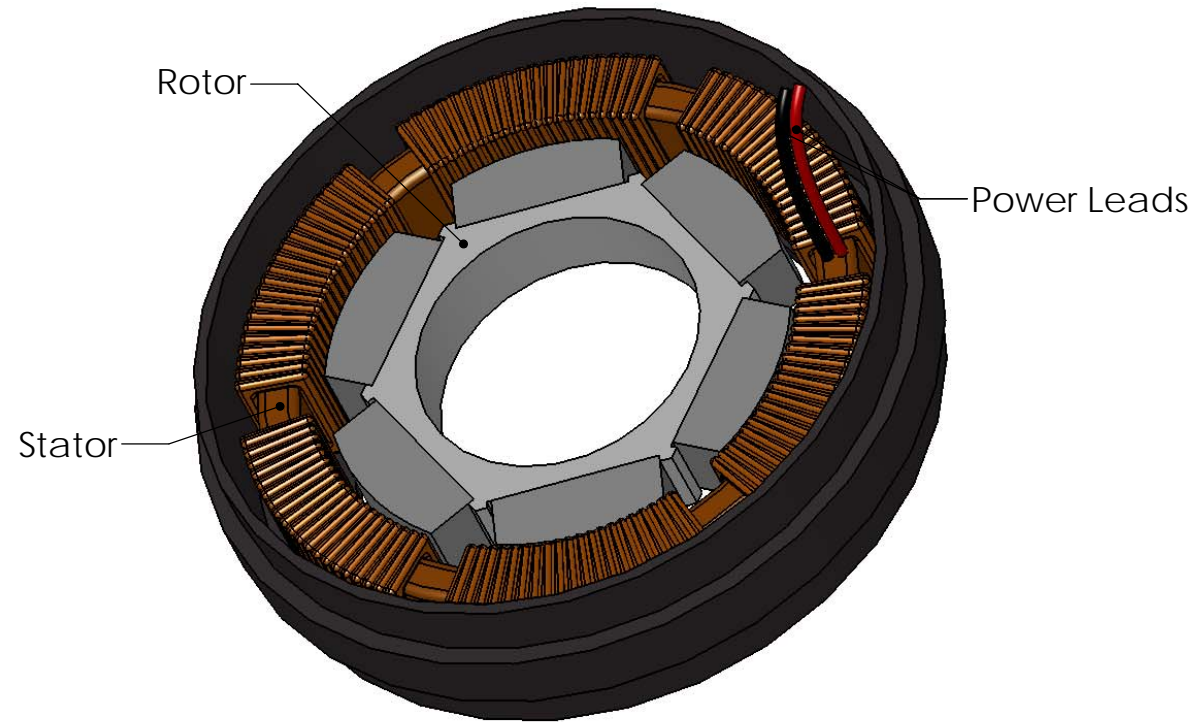

TOP

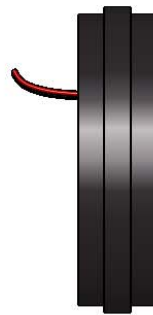

SIDE

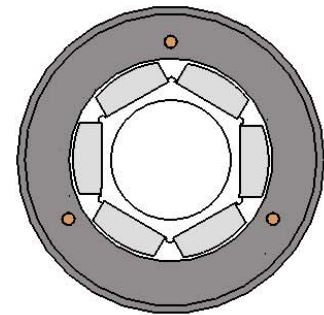

BACK

2 Pole MR Torquer

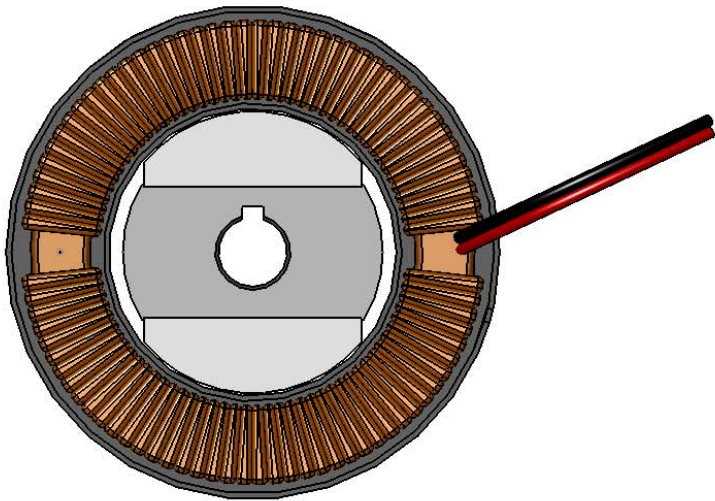

4 Pole MR Torquer

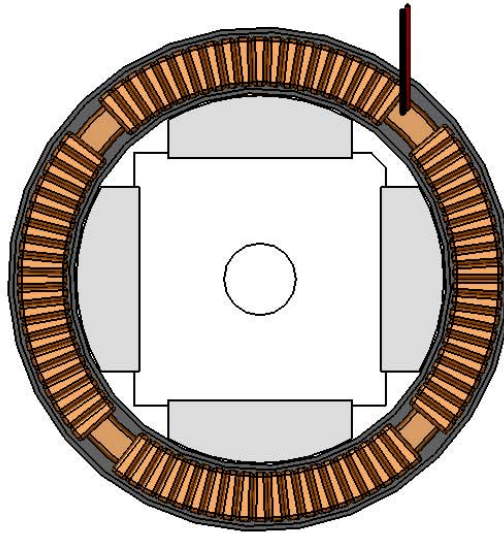

6 Pole MR Torquer

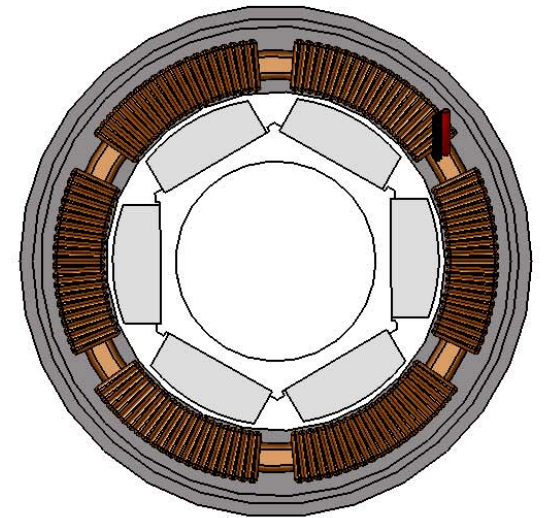

## LIMITED ANGLE TORQUE MOTORS

TMR-010-002-2H

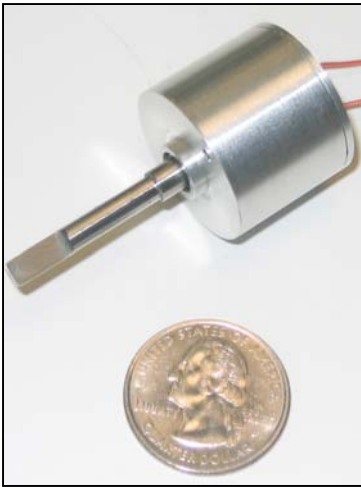

TMR-016-007-6



TMR-020-010-4



TMR-040-010-4

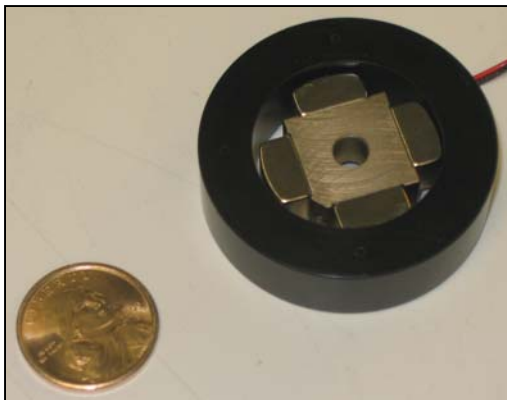

TMR-060-005-2

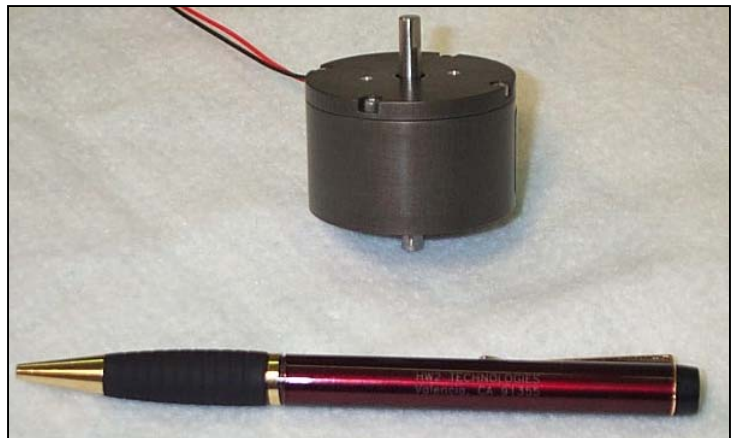

TMR-060-100-2V

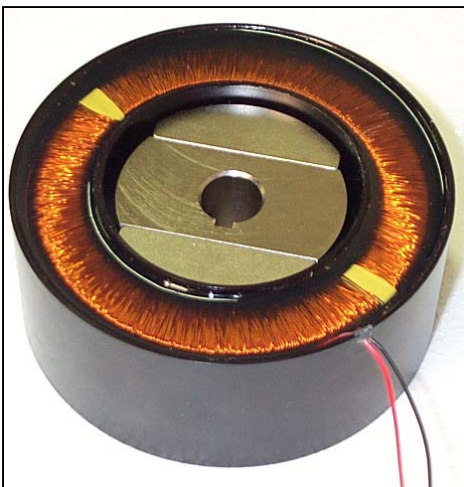

TMR-075-10-005-2H

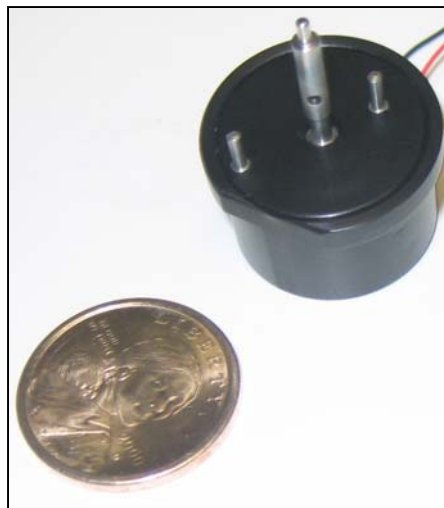

TWR-010-250-8LST

